









Ø8 x 35		Ø8 x 24					
A 22x	B 12x	C 12x	D 12x	E 8x	F 5x	G 8x	H 8x
							
Ø8 x 27			Ø3,5 x 16				
I 4x	J 8x	K 8x	L 20x	M 2x	N 1x	O 1x	P 2x



1



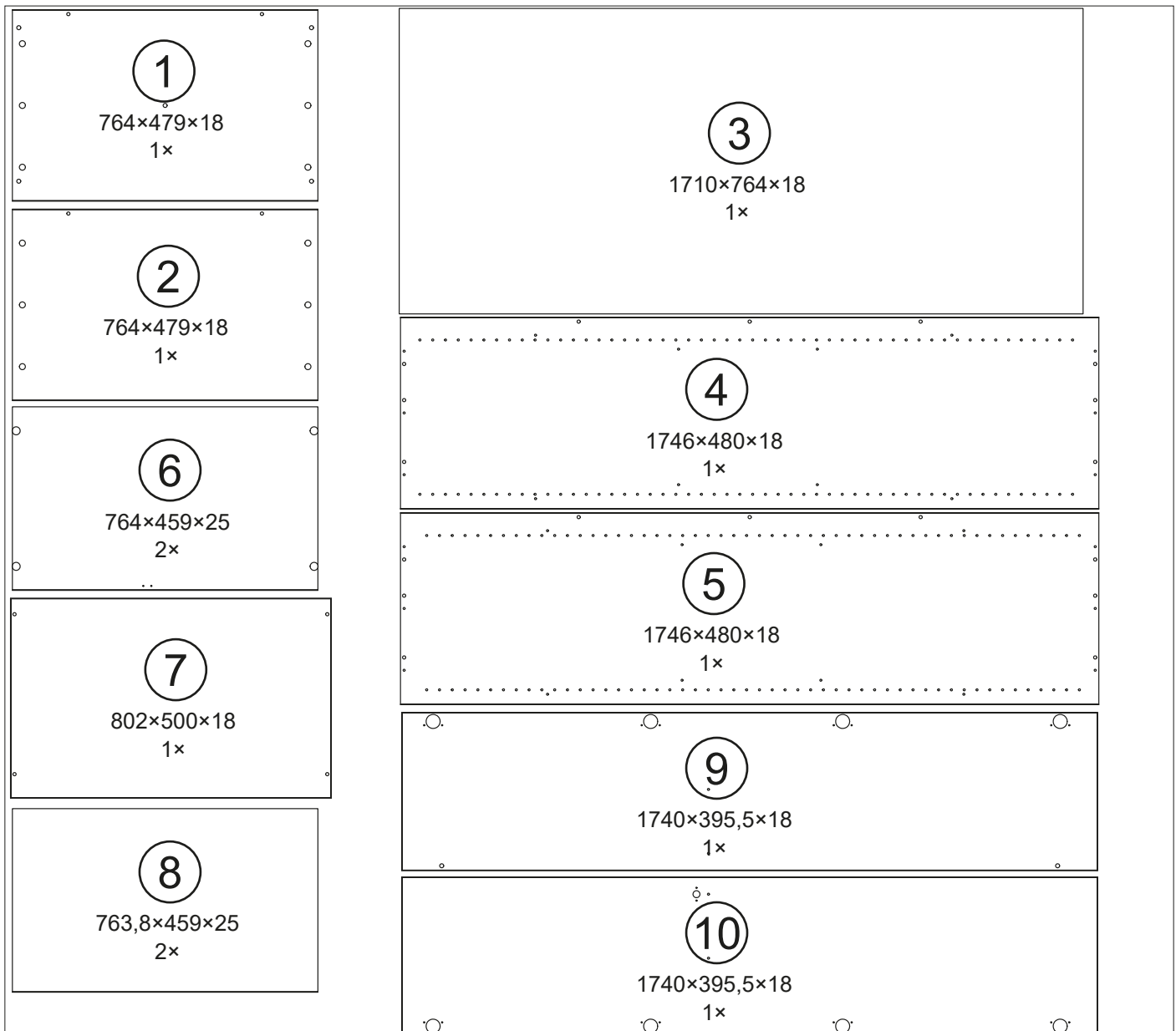
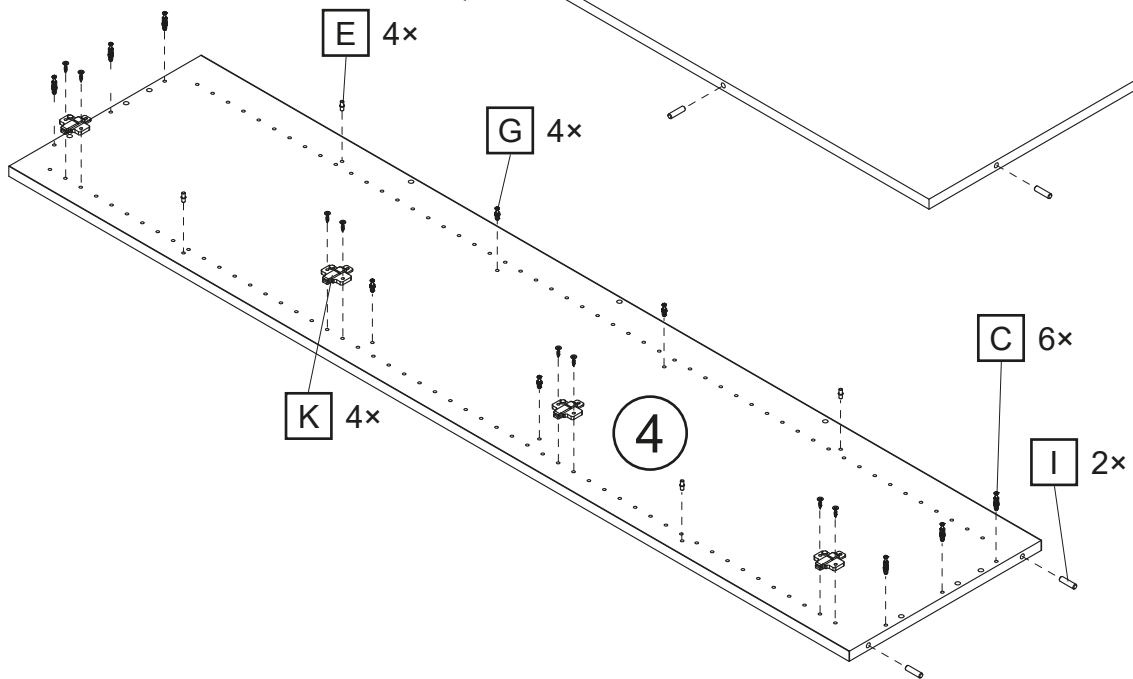
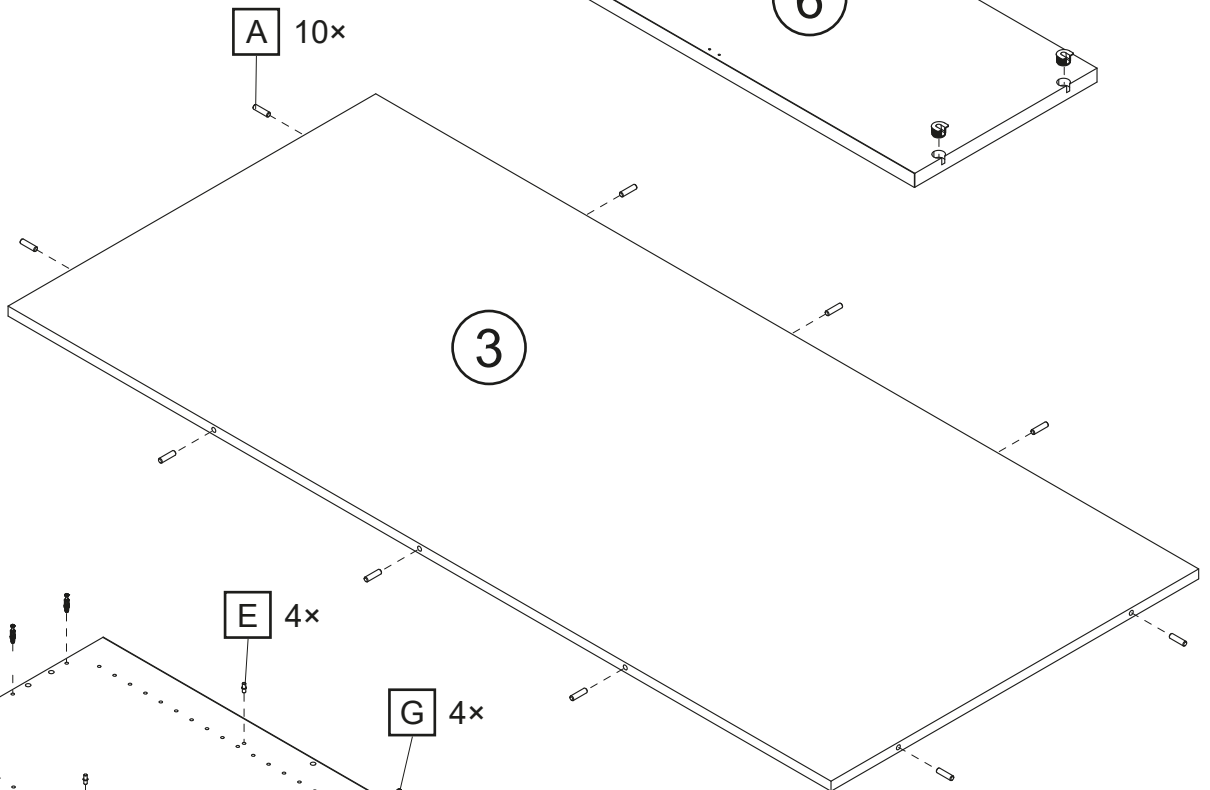
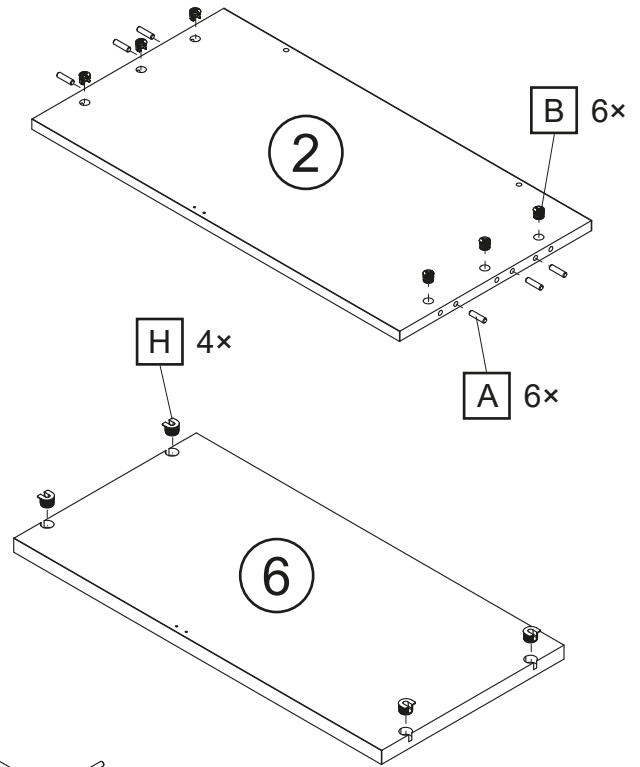
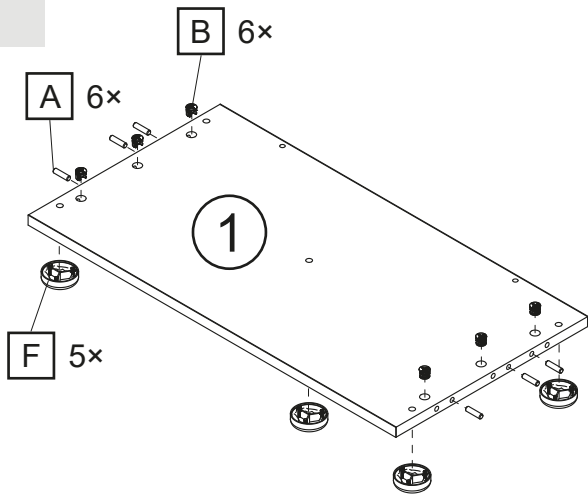
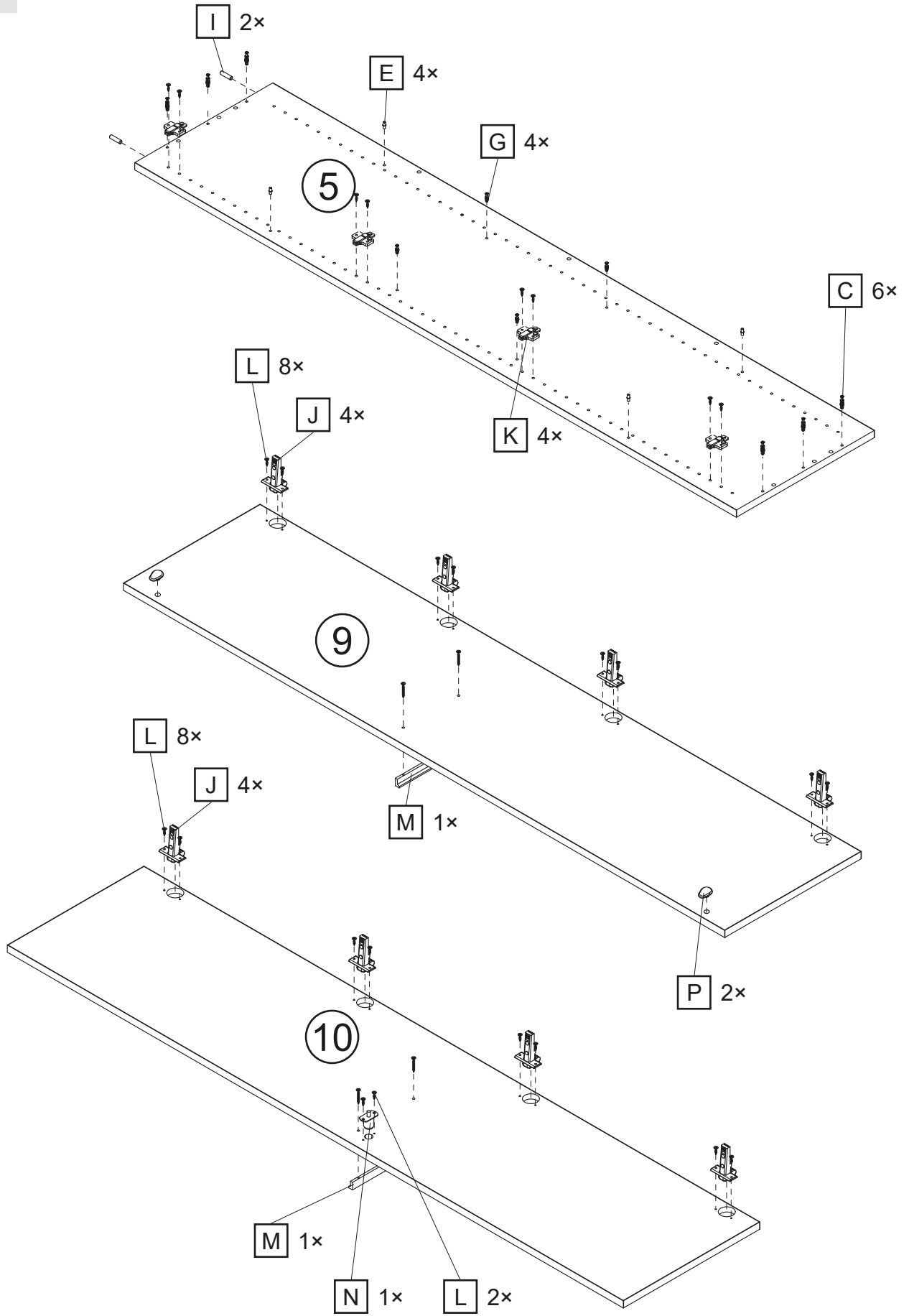

3

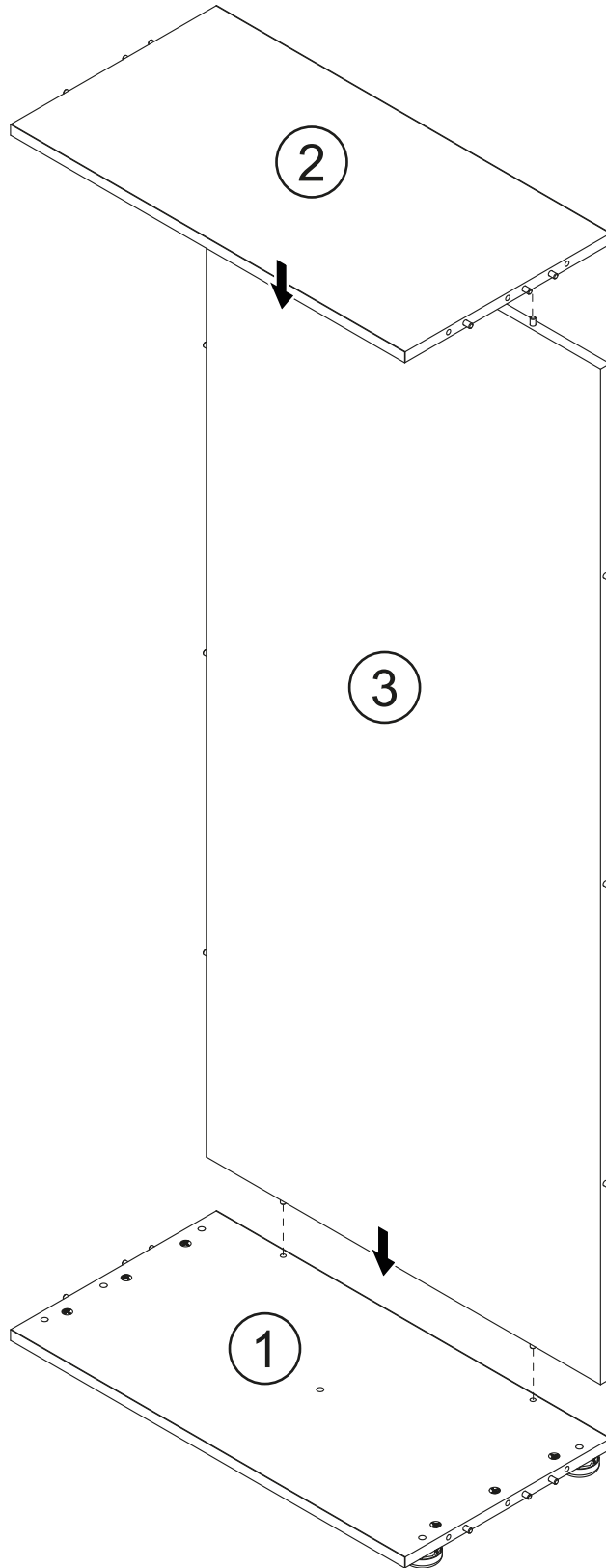

4

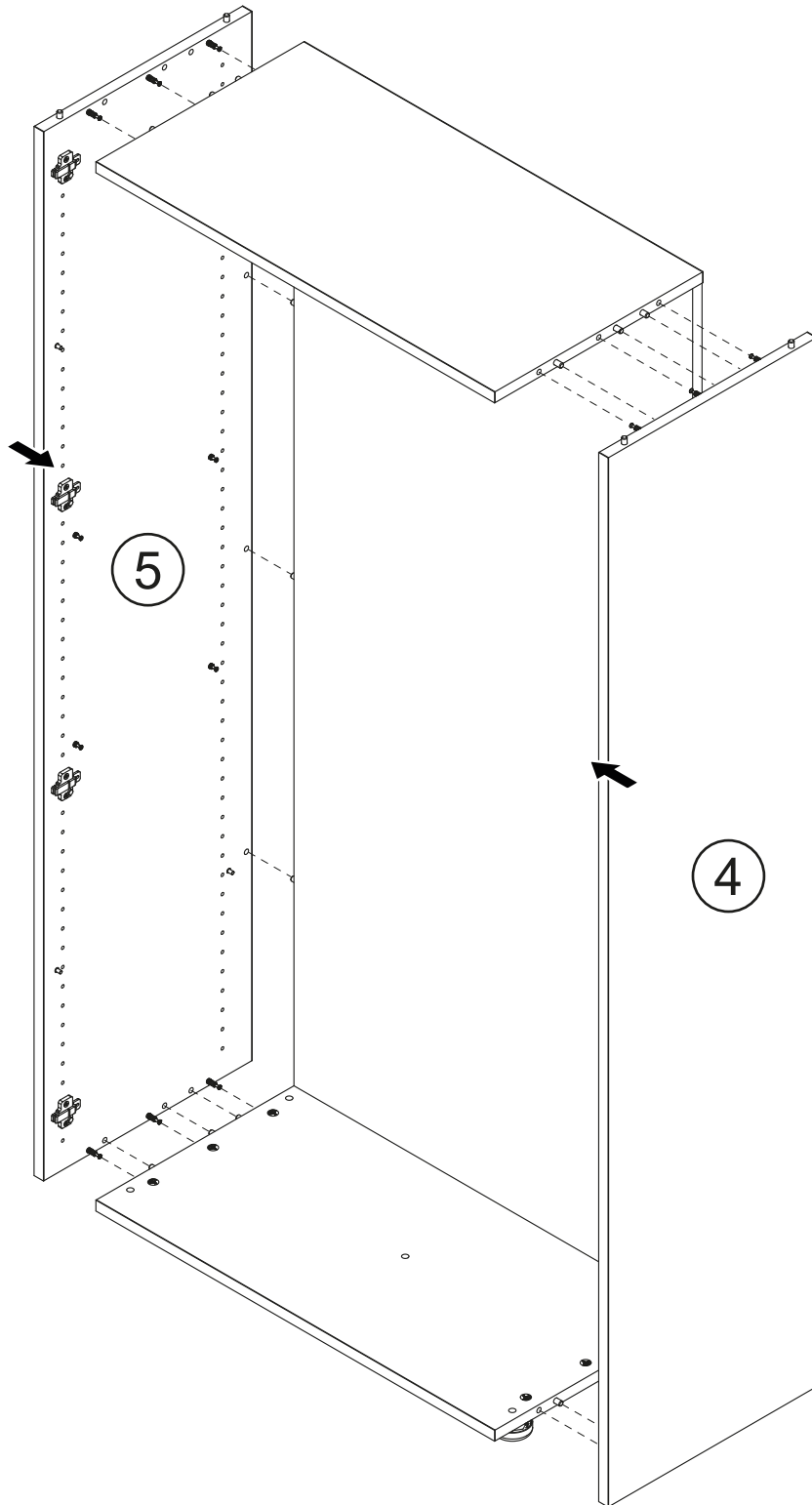

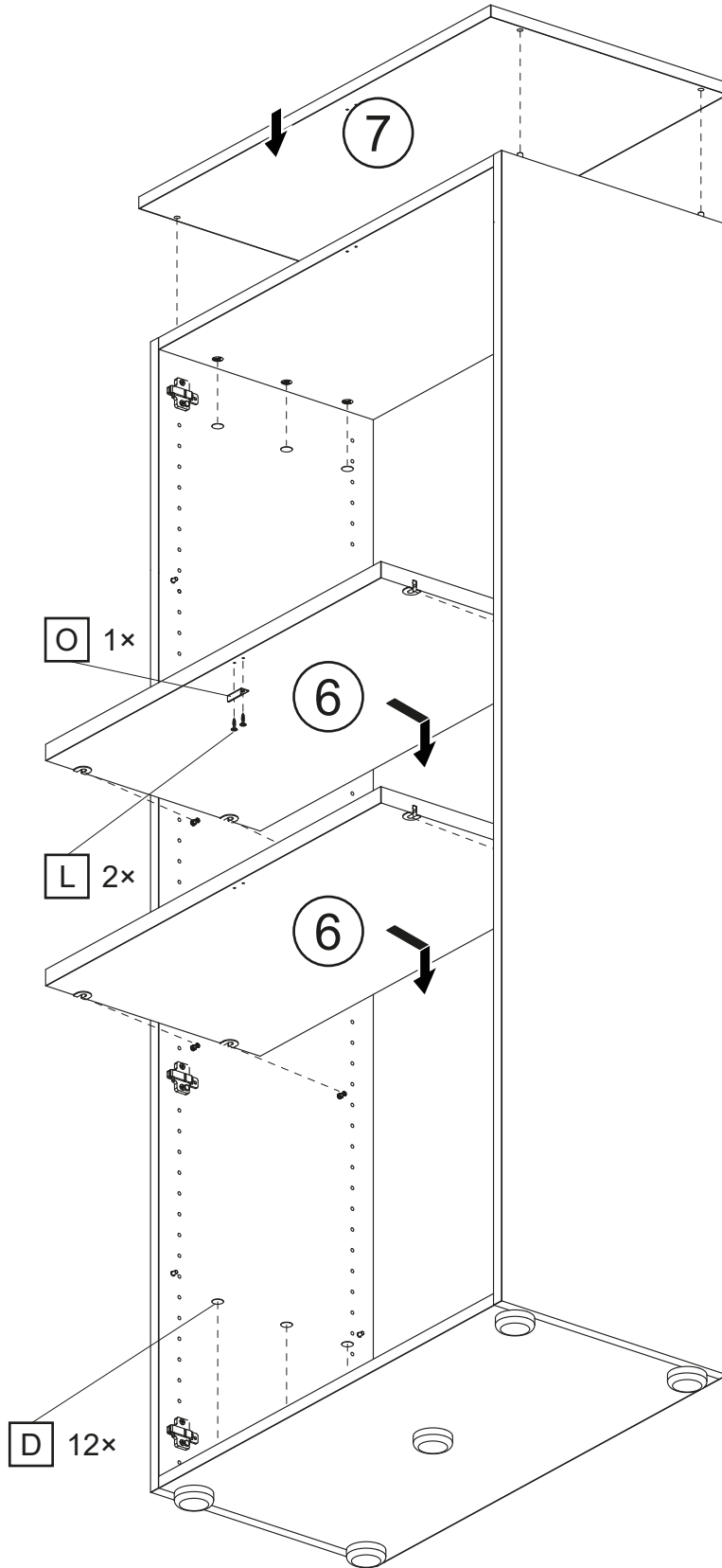

6

